

A SOLUTION YOU NEED

K.M.S
CANADA
LTD.
HARDWARE
CATALOGUE

2025.02

CONTENTS

Section 1	Staples, Nails, Screws and Bits	1-1
Section 2	Concealed Hinge Series	2-1
Section 3	Drawer Slides	3-1
Section 4	Handles and Knobs.....	4-1
Section 5	Baskets and Magic Corners	5-1
Section 6	Wood Carving	6-1
Section 7	Misc. Hardware	7-1
Section 8	Garbage Bins.....	8-1
Section 9	Closet and Storage.....	9-1

SECTION 1 STAPLES, NAILS, SCREWS AND BITS

SECTION 1.1 STAPLES AND NAILS

FINISH STAPLES - 18 GAUGE

Size	QTY/BOX
5/8" (16mm)	5000
3/4" (20mm)	5000
7/8" (22mm)	5000
1" (25mm)	5000
1-1/8" (28mm)	5000
1-1/4" (32mm)	5000
1-1/2" (38mm)	5000



BRAD NAILS - 18 GAUGE

Size	QTY/BOX
5/8" (16mm)	5000
3/4" (20mm)	5000
1" (25mm)	5000
1-1/4" (32mm)	5000
1-1/2" (38mm)	5000
1-3/4" (45mm)	5000
2" (50mm)	5000

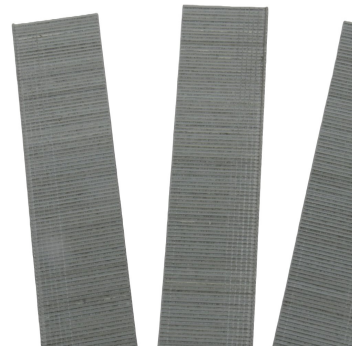

MICRO PINS - 23 GAUGE

Size	QTY/BOX
5/8" (16mm)	10000
3/4" (20mm)	10000
1" (25mm)	10000



Section 1 Staples, Nails, Screws

SECTION 1.2 WOOD SCREWS AND BITS

FEATURES:

- ❖ Woodworking particle board screws
- ❖ with deep thread and sharp point
- ❖ All fit for #2 square bit
- ❖ 45° Thread, Zinc, Type 17
- ❖ w/o nibs

6 SCREWS, FLAT HEAD



Item no.	Size	QTY / Box
816012	#6 × 1/2"	15000
816058	#6 × 5/8"	15000
816034	#6 × 3/4"	12000
816100	#6 × 1"	10000
816134	#6 × 1-3/4"	5000

8 SCREWS, FLAT HEAD



Item no.	Size	QTY / Box
818058	#8 × 5/8"	10000
818034	#8 × 3/4"	10000
818100	#8 × 1"	8000
818118	#8 × 1-1/8"	12000
818114	#8 × 1-1/4"	7500
818112	#8 × 1-1/2"	5000
818134	#8 × 1-3/4"	4000
818200	#8 × 2"	3500
818212	#8 × 2-1/2"	2500
818300	#8 × 3"	1500

Section 1 Staples, Nails, Screws

8 SCREWS, ROUND WASHER HEAD



Item no.	Size	QTY / Box
828058	#8 × 5/8"	10000
828118	#8 × 1-1/8"	6000
828114	#8 × 1-1/4"	4000
828212	#8 × 2-1/2"	2000
828300	#8 × 3"	1000

PAN HEAD



Item no.	Size	QTY / Box
836058	#6 × 5/8"	15000
838118	#8 × 5/8"	10000

EURO SCREW



Item no.	Size	QTY / Box
999003	M6.3 x 13 mm	7x1000(bag)

SECTION 2 CONCEALED HINGE SERIES

GENERAL SPECIFICATIONS AND FEATURES

Material: cold-rolled steel, nickel-plated finish

Opening angle: 30°, 45°, 90°, 105°, 135°, 165°, -15°, -30° and -45°

Three-dimensional adjustment. Soft closing or regular.

Full overlay, half overlay, inset models available

Mounting plates options.

Optional dowel and Euro screw available.

Diameter of hinge cup: 35mm (1-3/8 inch)

Depth of hinge cup: 11.3mm

Door thickness: 14 - 24mm

Standard packaging: 200 pcs/box

Special hinges for thicker door (more than 3/4”), big-angle hinges, are also available.

IDENTIFYING NUMBER OF HINGES NEEDED

For doors up to 24" (610 mm) wide, weighing up to:

20 lbs.,	use 2 hinges
20-40 lbs.,	use 3 hinges
40-60 lbs.,	use 4 hinges
60-80 lbs.,	use 5 hinges

Note: these recommendations are for doors without accessory attachments such as mirrors and racks.

MORE INFORMATION AS FOLLOWS:

For doors up to 24" (610 mm) wide and thickness 3/4" (19 mm), door height up to:

35" (900 mm)	use 2 hinges
63" (1600mm)	use 3 hinges
79" (2000mm)	use 4 hinges
94" (2400mm)	use 5 hinges

Section 2 Hinges

SECTION 2.1 105 DEGREE HINGE

SOFT CLOSING 105 DEGREE HINGE

K.M.S. H-3A



Full overlay

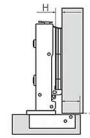

Hinge available with and without dowel. Available plates can be 5/8", 3/4", and also w/o euro screws.

K.M.S. H-3B



Half overlay

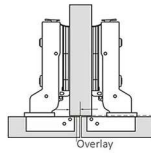

K.M.S. H-3C



Inset (zero overlay)

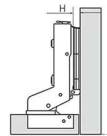

3/4 plate



REGULAR 105 DEG HINGE

K.M.S. H-2A



Full overlay

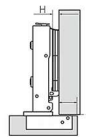

Note:

Hinge available with and without dowel.

Available plates can be 5/8", 3/4", and also w/o euro screws.

K.M.S. H-2B



Half overlay

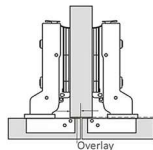

K.M.S. H-2C



Inset (zero overlay)

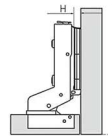

Section 2 Hinges

SECTION 2.2 CORNER HINGES

Corners hinges available: 30 deg, 45 deg, 90 deg, 165 deg (both soft closing and regular), and 135 deg bi-fold hinge. Also available certain sharp angle hinges: -15 deg, -30 deg and -45 deg.

KMS 45° HINGE

soft closing and regular



KMS 90° HINGE

soft closing and regular



KMS 30° HINGE

soft closing and regular



KMS 135° HINGE



KMS 165° HINGE

soft closing and regular



KMS -15° HINGE



KMS -30° HINGE

soft closing and regular



KMS -45° HINGE

soft closing and regular



Section 2 Hinges

SECTION 2.3 BLUM AND SALICE HINGES

BLUM HINGES

Blum 107° soft closing hinge
71B3550 / 71B3580



Blum 107° regular hinge
71B1550 / 71B1580



Blum 45° soft closing hinge
79B3558



Blum 90° soft closing hinge
79B9550

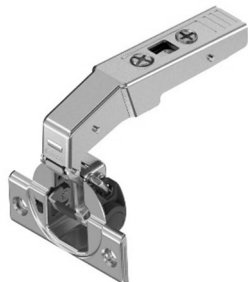

Blum 135° hinge
79T8500



Blum 170° hinge
71T6550



Plate 173H7100



Plate 174H7100



Plate 175H7100

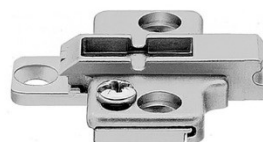

SALICE 135° AND 165° HINGE

Salice 135° hinge C2RYA99



Salice 165° hinge C2RFA99

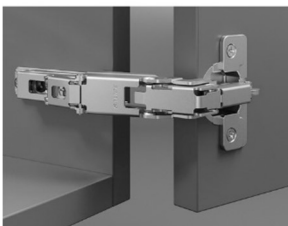

Salice hinge plate BAR3R29



SECTION 2.4 PUSH OPEN HINGES AND LATCHES

PUSH OPEN HINGE AND PUSH OPEN LATCH / HOLDER

K.M.S. H6-A



Push-Release Latch H6-AL



UNSPRUNG HINGE WITH PISTON LATCH

K.M.S. H6-B



Magnetic Push Latch H6-BL



SELF-CLOSING HINGE WITH LATCH

K.M.S. H6-C



Bumper Push Latch H6-CL



SECTION 3 DRAWER SLIDES

Our company carries several types of draw slides for your different usage and application:

- ❖ RSS - Regular (non-softclosing) Sidemount Slide
- ❖ PSS - Pushopen Sidemount Slide
- ❖ SSS - Softclosing Sidemount Slide
- ❖ SUS - Softclosing Undermount Slide
- ❖ PUS - Pushopen Undermount Slide
- ❖ RMS - Regular (non softclosing) Metalbox Slide
- ❖ RRS - Regular Roller Slide
- ❖ SMS - Softclosing Metalbox Slide (slim double wall slide)

Installation instruction for these slides is available on our website: www.kmscanada.com

Section 3 Drawer Slides

SECTION 3.1 SIDEMOUNT FULL EXTENSION DRAWER SLIDES



REGULAR SIDEMOUNT BALL BEARING DRAWER SLIDES

K.M.S. RSS

SPECIFICATIONS & FEATURES:

Height: 1.8" (45.7mm)

Side Clearance: 1/2" (12.7mm) + 1/32"

SIZE: 8", 10", 12", 14", 16", 18", 20", 22", 24"

Capacity: 100 lbs (45 kg) per pair

Finish: Zinc

Mounting: side

Action: Steel ball bearings

Qty/box: 15 pairs

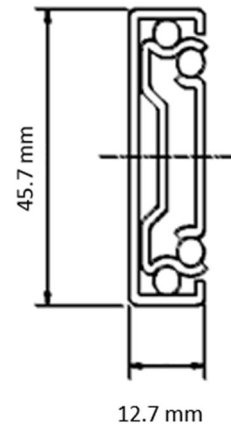

PUSH-OPEN SIDEMOUNT BALL BEARING DRAWER SLIDES

K.M.S. PSS

SPECIFICATIONS & FEATURES:

Height: 1.8" (45.7 mm)

Side Clearance: 1/2" (12.7 mm) + 1/32"

SIZE: 12", 14", 16", 18", 20"

Capacity: 100 lbs (45 kg) per pair

Finish: Zinc

Action: Steel ball bearings

Qty/box: 15 pairs

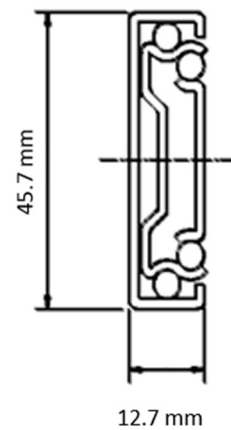

Section 3 Drawer Slides

SECTION 3.2 SYNCHRONIZED FULL EXTENSION UNDERMOUNT SLIDES

SOFT CLOSING FULL EXTENSION UNDERMOUNT SLIDES WITH 6-WAY ADJUSTMENT

K.M.S. SUS

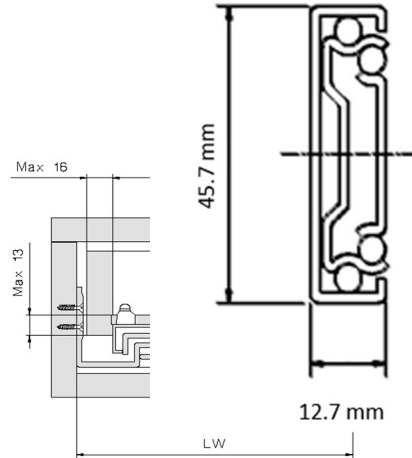

SPECIFICATIONS & FEATURES:

Dynamic load: 77 lbs (35 kg) per pair

Mounting: Bottom, full extension

Size: 10", 12", 14", 16", 18", 20", 22".24"

3 way adjustment

Finish: Zinc.

Qty/box: 10 pairs

PUSH-OPEN, FULL EXTENSION UNDERMOUNT SLIDES

K.M.S. PUS

SPECIFICATIONS & FEATURES:

Dynamic load: 77 lbs (35 kg) per pair

Mounting: Bottom, full extension

Size: 12", 14", 16", 18", 20"

Finish: Zinc.

The drawer can be very easily mounted and dismantled on the runner.

Qty/box: 10 pairs.

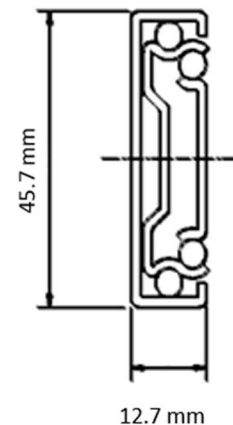

SECTION 3.3 ROLLER MECHANISM SLIDES

REGULAR METALBOX DRAWER SLIDES

K.M.S. RMS

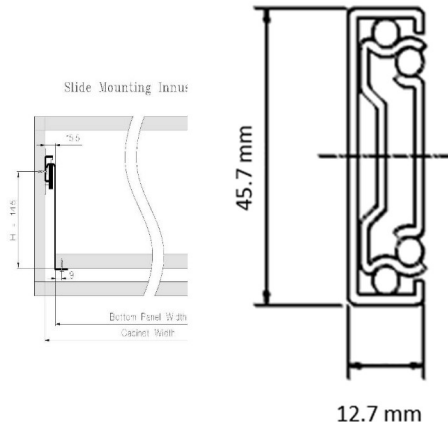

SPECIFICATIONS & FEATURES:

Capacity: 100 lbs (45 kg) per pair.

Finish: White.

Height: 3-3/8" (85mm), 5-7/8" (150mm)

Thickness: 1.2 mm.

Size: 16", 18", 20"

Qty/box: 10 pairs.

Self-closing system, Lock-out stop, 2-dimensional front adjustment, super silent, soft closing mechanism available.

REGULAR SELF-CLOSING ROLLER SLIDES

K.M.S. RRS

SPECIFICATIONS & FEATURES:

Capacity: 55 lbs (25 kg) per pair.

Finish: White.

Size: 16", 18", 20", 22"

Qty/box: 20 pairs.

Self-closing system, Double stop positions, super silent, soft closing available

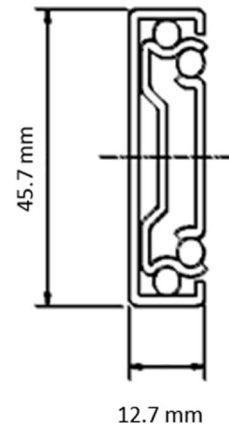

Section 3 Drawer Slides

SECTION 3.4 SOFT CLOSING SIDEMOUNT DRAWER SLIDES

K.M.S. SSS



SPECIFICATIONS & FEATURES:

Height: 1.8" (45.7mm).

Side Clearance: 1/2" (12.7mm) (+0.5-0mm).

Size: 10", 12", 14", 16", 18", 20", 22", 24", 26", 28"

Mounting: Side, full extension

Dynamic load: 75 lbs (34 kg) per pair.

Finish: Zinc.

Qty/box: 15 pairs.

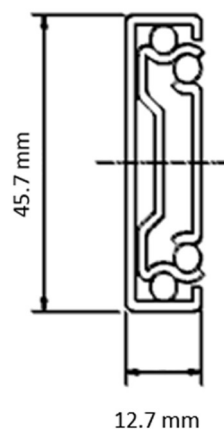

More information please check website: kmscanada.com.

SECTION 3.5 SLIM DOUBLEWALL METAL BOX SOFT CLOSING DRAWER SLIDES

K.M.S. SMS



SPECIFICATIONS & FEATURES:

Concealed, full extension.

Dynamic load: 100 lbs (45 kg) per pair

Finish: white and Grey

The drawer can be very easily mounted and dismantled on the runners.

Size: 12", 14", 16", 18", 20", 22"

Qty/box: 6 pairs/carton.

3-dimensional front cam big adjustment

Height: 88 mm (3-1/2")

171 mm (6-3/4")

202 mm (8")

Other information please see website: kmscanada.com

Section 4 Handles and Knobs

SECTION 4 HANDLES AND KNOBS

HK1 BN



Finish: brush nickel (BN)

Size (cc): 96, 128, 160, 192, 224, 288, 416, 480 mm

Width: 10mm

Height: 30 mm

HK1 B and HK1 G



Finish: black (B) or gold (G)

Size (cc): 96, 128, 224 mm

Width: 10 mm

Height: 30 mm

HK2



Finish: brush nickel (BN)

Size (cc): 96, 128, 160 mm

Width: 5 mm

Height: 30 mm

HK3A



Finish: brush nickel (BN)

Size(cc): 128, 160 mm

Width: 26 mm

Height: 26 mm

HK4A(new)



Finish: brush nickel (BN), black, chrome, gold, champagne bronze (CB)

Size(cc): 128, 192, 320 mm

Width: 7 mm

Height: 30 mm

Section 4 Handles and Knobs

HANDLES AND KNOBS (CONT'D)

HK5A



Finish: brush nickel (BN), chrome, black, gold

Size(cc): 128, 160, 224 mm

Width: 9 mm

Height: 32 mm

HK6



Finish: brush nickel (BN)

Size(cc): 96, 128, 160 mm

Width: 16 mm

Height: 25 mm

HK7



Finish: brush nickel (BN), black

Size(cc): 96, 128 mm

Width: 7 mm

Height: 26 mm

HK8A



Finish: brush nickel (BN) with chrome tone

Size(cc): 96, 128 mm

Width: 15 mm

Height: 22 mm

HK9A



Finish: brush nickel (BN), black, gold

Size(cc): 128, 160, 192 mm

Width: 13 mm

Height: 26 mm

Section 4 Handles and Knobs

HANDLES AND KNOBS (CONT'D)

HK10



Finish: brush nickel (BN)

Size(cc): 128 mm

Width: 13 mm

Height: 25 mm

HK10A



Finish: glassy black (GB), brush nickel (BN), chrome

Size(cc): 128 mm

Width: 12 mm

Height: 25 mm

HK11A



Finish: brush nickel (BN)

Size(cc): 96, 128, 160, 192, 224 mm

Width: 20 mm

Height: 26 mm

HK11B

Photo needed

Finish: brush nickel (BN)

Size(cc): 96, 128 mm

Width: 13 mm

Height: 29 mm

HK12A



Finish: brush nickel (BN)

Size(cc): 128 mm

Width: 12 mm

Height: 29 mm

Section 4 Handles and Knobs

HANDLES AND KNOBS (CONT'D)

HK13A



Finish: brush nickel (BN)

Size(cc): 160, 192 mm

Width: 21 mm

Height: 25 mm

HK14A



Finish: brush nickel (BN)

Size(cc): 160, 224 mm

Width: 22 mm

Height: 23 mm

HK15A



Finish: brush nickel (BN)

Size(cc): 128 mm

Width: 20 mm

Height: 25 mm

HK16A



Finish: brush nickel (BN), black, gold

Width: 30 mm

Height: 22 mm

HK17



Finish: brush nickel (BN)

Size(cc): 128 mm

Width: 23 mm

Height: 22 mm

Section 4 Handles and Knobs

HANDLES AND KNOBS (CONT'D)

HK18A(new)



Finish: black, gold
Size(cc): 128, 192, 320
Width: 10 mm
Height: 33 mm

HK18B(new)



Finish: black, gold
Width: 27 mm
Height: 33 mm

HK19A



Finish: brush nickel (BN)
Size(cc): 128, 160, 192
Width: 20 mm
Height: 23 mm

HK20



Finish: brush nickel (BN)
Size(cc): 128 mm
Width: 18 mm
Height: 25 mm

HK21A(new)



Finish: brush nickel (BN), black, gold, champagne bronze (CB)
Size(cc): 128, 192, 320
Width: 5 mm
Height: 33 mm

Section 4 Handles and Knobs

HANDLES AND KNOBS (CONT'D)

HK22A



Finish: black, gold
 Width: 27 mm
 Height: 33 mm

HK23A (hidden handle)

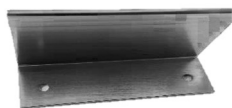

Finish: brush nickel (BN), chrome, black
 Size(cc): 64, 224
 Depth: 44 mm
 Height: 24 mm

HK23B (hidden handle)



Finish: brush nickel (BN), gold, black, champagne bronze (CB)
 Size(cc): 50, 96, 224 mm
 Depth: 40 mm
 Height: 19 mm

HK24



Finish: brush nickel (BN)
 Size(cc): 96, 128, 160, 192
 Width: 5 mm
 Height: 32 mm

HK25A(new)



Finish: brush nickel (BN), black, gold
 Size(cc): 128, 192, 320
 Width: 6 mm
 Height: 34 mm

Section 4 Handles and Knobs

HANDLES AND KNOBS (CONT'D)

HK25B (new)



Finish: black, gold
Width: 32 mm
Height: 32 mm

HK26



Finish: brush nickel (BN), chrome, black, glassy black (GB), antique bronze (AB), oil rinsed bronze (ORB)
Width: 30 mm
Height: 25 mm

HK28A

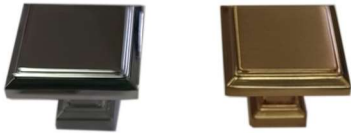

Finish: brush nickel (BN), black, chrome, gold, champagne bronze (CB)
Width: 30 mm
Height: 26 mm

HK29 (oval shape)



Finish: brush nickel (BN)
Width: 30 mm
Height: 30 mm

HK30



Finish: oil rinsed bronze (ORB)
Size(cc): 96 mm
Height: 30 mm
Also available in brush nickel (BN) finish with size 64 mm (cc).

Section 4 Handles and Knobs

HANDLES AND KNOBS (CONT'D)

HK32



Finish: brush nickel (BN)
width: 30 mm
Height: 25 mm

HK33



Finish: brush nickel (BN), black, vintage brass (VB)
Width: 30 mm
Height: 25 mm

HK34



Finish: brush nickel (BN), black, gold, oil rinsed bronze (ORB)
Width: 30 mm
Height: 25 mm

HK35



Finish: brush nickel (BN), black
Size(cc): 96 mm (BN and black), 128 mm (Black)
Width: 15 mm
Height: 25 mm

HK36



Finish: oil rinsed bronze (ORB), weather silver (WS)
Size(cc): 76 mm
Width: 12 mm
Height: 25 mm

Section 4 Handles and Knobs

HANDLES AND KNOBS (CONT'D)

HK37



Finish: brush nickel (BN)

Size(cc): 96, 128, 160, 192, 224, 288, 320 mm

Width: 14 mm

Height: 35 mm

HK38



Finish: brush nickel (BN), gold, black, champagne bronze (CB)

Size(cc): BN - 128, 160, 192, 224, 320, 448 mm

Black - 128, 160, 192, 224, 320 mm

Gold - 128, 160, 192, 320 mm

CB - 128, 160, 224, 320 mm

Width: 5 mm

Height: 28 mm

HK39



Finish: brush nickel (BN)

Size(cc): 76 mm

Width: 10 mm

Height: 28 mm

HK40



Finish: brush nickel (BN), oil rinsed bronze (ORB), chrome

Size(cc): 128, 160 mm

Width: 17 mm

Height: 25 mm

HK41



Finish: brush nickel (BN)

Size: 76 mm

Width: 17 mm

Height: 20 mm

Section 4 Handles and Knobs

HANDLES AND KNOBS (CONT'D)

HK42



Finish: brush nickel (BN), chrome, black, gold, champagne bronze (CB)
 Size: BN - 96, 128, 160, 192, 256, 320
 Chrome - 128, 160, 256, 320
 Black / gold / CB - 128, 160, 192, 320
 Width: 13 mm
 Height: 26 mm

HK43A

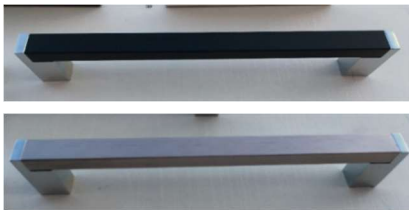

Finish: tube anodize or black + polished chrome zinc alloy feet
 Size(cc): 128, 160, 192, 320 mm
 Width: 12 mm
 Height: 30 mm

HK44A(new)



Finish: brush nickel (BN), gold, black, champagne bronze (CB)
 Size(cc): 128, 192, 320 mm
 Width: 10 mm
 Height: 30 mm

HK44B(new)



Finish: brush nickel (BN), gold, black, champagne bronze (CB)
 Width: 33 mm
 Height: 30 mm

HK45



Finish: brush nickel (BN), gold, black
 Size(cc): 128, 160, 224 mm
 Width: 13 mm Height: 25 mm

Section 4 Handles and Knobs

HANDLES AND KNOBS (CONT'D)

HK46



Finish: brush nickel (BN), gold, black, chrome, champagne bronze (CB)
 Size: 128, 160, 192, 320 mm
 Width: 8.5 mm
 Height: 25 mm

HK47C(new)



Finish: brush nickel (BN), gold, black, champagne bronze (CB), chrome
 Size(cc): 128, 192, 320 mm
 Width: 7.5 mm
 Height: 30 mm

HK48A(new)



Finish: brush nickel (BN), gold, black, champagne bronze (CB)
 Size(cc): 128, 192, 320 mm
 Width: 10 mm
 Height: 30 mm

HK48B(new)



Finish: brush nickel (BN), gold, black, champagne bronze (CB)
 Width: 32 mm
 Height: 27 mm

HK49



Finish: brush nickel (BN)
 Size: 160 mm
 Width: 12 mm
 Height: 30 mm

Section 4 Handles and Knobs

HANDLES AND KNOBS (CONT'D)

HK49A



Finish: brush nickel (BN)

Size(cc): 128 mm

Width: 12 mm

Height: 30 mm

HK50



Finish: brush nickel (BN)

Size(cc): 128, 160, 224, 288 mm

Width: 11 mm

Height: 30 mm

HK51



Finish: brush nickel (BN, black)

Width: 35 mm

Height: 20 mm

HK52



Finish: brush nickel (BN), black, gold, champagne bronze (CB), chrome

Width: 32 mm

Height: 20 mm

HK52A

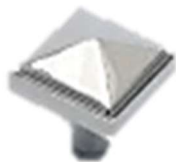

Finish: brush nickel (BN), black, gold, champagne bronze (CB), chrome

Width: 30 mm

Height: 30 mm

Section 4 Handles and Knobs

HANDLES AND KNOBS (CONT'D)

HK53



Finish: brush nickel (BN), chrome, black, gold, champagne bronze (CB), oil rinsed bronze (ORB)

Width: 44 mm

Height: 15 mm

HK54



Finish: oil rinsed bronze (ORB)

Size(cc): 128 mm

Width: 35 mm

Height: 20 mm

HK55A(new)



Finish: brush nickel (BN), gold, black

Width: 33 mm

Height: 30 mm

HK56A(new)



Finish: brush nickel (BN), gold, black

Size(cc): 128, 160, 320 mm

Width: 8mm

Height: 30 mm

HK57



Finish: brush nickel (BN), oil rinsed bronze (ORB)

Size: BN - 96, 128, 160, 192, 224, 320 mm

ORB - 128, 160, 320 mm

Width: 13 mm

Height: 25 mm

Section 4 Handles and Knobs

HANDLES AND KNOBS (CONT'D)

HK58A(new)



Finish: black, gold
Size(cc): 128, 192, 320 mm
Width: 13 mm
Height: 28 mm

HK59



Finish: brush nickel (BN), black
Size(cc): BN - 128, 192 mm
 black - 128 mm
Width: 17 mm
Height: 34 mm

HK60



Finish: brush nickel (BN), black, gold, champagne bronze (CB)
Width: 35 mm
Height: 30 mm

HK61



Finish: brush nickel (BN), oil rinsed bronze (ORB)
Width: 30 mm
Height: 30 mm

HK62



Finish: brush nickel (BN)
Width: 32 mm
Height: 30 mm

Section 4 Handles and Knobs

HANDLES AND KNOBS (CONT'D)

HK63



Finish: oil rinsed bronze (ORB)
Width: 32 mm
Height: 30 mm

HK64



Finish: brush nickel (BN)
Width: 28 mm
Height: 18 mm

HK65A

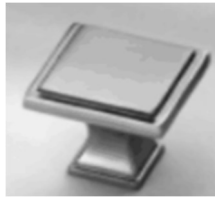

Finish: brush nickel (BN), chrome, gold, black
Width: 30 mm
Height: 30 mm

HK66



Finish: brush nickel (BN), chrome
Width: 30 mm
Height: 28 mm

HK67



Finish: oil rinsed bronze (ORB)
Width: 32 mm
Height: 28 mm

Section 4 Handles and Knobs

HANDLES AND KNOBS (CONT'D)

HK68 (oval shape)



Finish: oil rinsed bronze (ORB)
 Width: 36 mm
 Height: 25 mm

HK69



Finish: oil rinsed bronze (ORB)
 Size(cc): 76 mm
 Width: 10 mm
 Height: 32 mm

HK70



Finish: brush nickel (BN) / chrome dual tone
 Size(cc): 128, 160 mm
 Width: 25 mm
 Height: 30 mm

HK71



Finish: brush nickel (BN), chrome, gold, black, oil rinsed bronze (ORB), vintage brass (VB), champagne bronze (CB)
 Size(cc): ORB - 128 mm only
 others in 128, 192, 320 mm
 Width: 12 mm
 Height: 28 mm

HK72



Finish: brush nickel (BN)
 Size(cc): 96, 128, 192 mm
 Width: 20 mm
 Height: 24 mm

Section 4 Handles and Knobs

HANDLES AND KNOBS (CONT'D)

HK73



Finish: brush nickel (BN)
Width: 32 m
Height: 20 mm

HK74



Finish: brush nickel (BN)
Size(cc): 128, 160, 192
Width: 15 mm
Height: 25 mm

HK75



Finish: brush nickel (BN)
Size(cc): 96, 128, 160 mm
Width: 12 mm
Height: 25 mm

HK76



Finish: brush nickel (BN)
Size(cc): 128, 160, 224 mm
Width: 24 mm
Height: 35 mm

HK77



Finish: brush nickel (BN), chrome
Width: 30 m
Height: 15 mm

Section 4 Handles and Knobs

HANDLES AND KNOBS (CONT'D)

HK78



Finish: brush nickel (BN)

Size(cc): 160, 320 mm

Width: 23 mm

Height: 25 mm

HK79



Finish: brush nickel (BN), chrome

Width: 32 mm

Height: 30 mm

HK80



Finish: brush nickel (BN), black, gold

Width: 40 mm

Height: 33 mm

HK81A (new)



Finish: K gold, black

Size(cc): 128, 192, 320

Width: 7 mm

Height: 30 mm

HK81B (new)



Finish: K gold, black

Width: 32 mm

Height: 30 mm

Section 4 Handles and Knobs

HANDLES AND KNOBS (CONT'D)

HK82 (new)



Finish: brush nickel (BN), gold, black

Size(cc): 128, 192, 320

Width: 12 mm

Height: 32 mm

HK83 (new)



Finish: brush nickel (BN), black, chrome, gold, champagne bronze (CB)

Size(cc): 128, 192, 320 mm

Width: 12 mm

Height: 30 mm

HK84 (new)



Finish: black, gold

Size(cc): 128, 160, 320 mm

Width: 14 mm

Height: 34 mm

HK101



Finish: black (body) / gold (leg), gold (body) / black (leg)

Size(cc): 96, 128, 224 mm

Width: 12 mm

Height: 32 mm

HK101 Knob



Finish: black (body) / gold (leg), gold (body) / black (leg)

Width: 10 mm

Height: 32 mm

Section 4 Handles and Knobs

HANDLES AND KNOBS (CONT'D)

HK102 (new)



Finish: black (body) / gold (leg), gold (body) / black (leg)

Size(cc): 96, 128, 224 mm

Width: 10 mm

Height: 32 mm

HK102 Knob (new)



Finish: black (body) / gold (leg), gold (body) / black (leg)

Width: 10 mm

Height: 32 mm

Section 5 Baskets and Magic Corners

SECTION 5 BASKETS AND MAGIC CORNERS

Section 5.1 Side Drawer Basket (Universal and Soft Closing)



Section 5.2 Pantry Unit (Soft Closing)



Section 5.3 Lazy Susan



Section 5.4 Magic Corners (Soft Closing)



Section 5.5 Swing Trays (Soft Closing)



Section 5.6 Misc (Pull Out Basket, Stove Drawer Basket)



Section 5 Baskets and Magic Corners

SECTION 5.1 SIDE DRAWER BASKET (UNIVERSAL AND SOFT CLOSING)



Section 5 Baskets and Magic Corners

SPICY RACKS WITH WOOD BOTTOM BASKETS

FEATURES:

- ❖ soft closing
- ❖ door mounting (with L and T connectors)
- ❖ very strong with undermount slides
- ❖ Basket position movable
- ❖ Loading capacity **30 kg (66 lbs)**
- ❖ Universal installation

	Basket size (inch)	Cabinet size (inch)	
KMS 21-15HS	4 $\frac{1}{2}$	6	Height: 26-1/2"
KMS 21-20HS	6	8	or 23"
KMS 21-25HS	8	10	Depth: 19"
KMS 21-30HS	10	12	

SPICY RACK FOR 16" SIZE CABINET



KMS 21-403

- ❖ Soft closing track
- ❖ Dimension: **13 $\frac{3}{4}$ "** width x **19"** depth
- ❖ Height adjustable: 25 - 30 inches
- ❖ 3 Wire Baskets
- ❖ Steady with top and bottom mounting
- ❖ 2-pieces Door mounting

Also available with wood-plate bottom baskets

KMS 21-403Wood

Section 5 Baskets and Magic Corners

PULL-OUT RACKS FOR UPPER CABINET

KMS 11-SP2S: 2 layers (20" high)

KMS 11-SP3S: 3 layers (25" high)

- ❖ Dimension: $4\frac{1}{2}$ " (width) x 11" (depth)
- ❖ Door mounting
- ❖ Strong with undermount slides

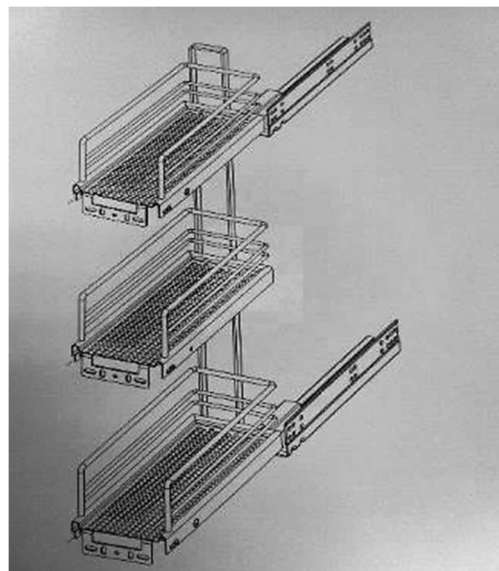

PULL-OUT RACKS FOR UNDERSINK



KMS 11-SUS

- ❖ Soft closing track
- ❖ Dimension (WDH): 11x18x16 inches
- ❖ Two baskets
- ❖ With waterdrop plate

Section 5 Baskets and Magic Corners

KITCHEN SORTING BASKET



KMS 21-35-15

WDH: 105 mm x 470mm x 1650mm (4-1/4" x 18-1/2" x 65")

Section 5 Baskets and Magic Corners



Section 5 Baskets and Magic Corners



Section 5 Baskets and Magic Corners

SECTION 5.2 PANTRY UNITS WITH GRASS TRACK

FEATURES:

- ❖ Equipped with soft clsonig undermount GRASS tracks
- ❖ Heavy duty
- ❖ Basket with wire and solid plate and glass
- ❖ multi-pieces door mounting
- ❖ Basket position movable
- ❖ Loading capacity: 70 kg (154 lbs)

ITEM NO.	DIMENSION (INCH) (WDH)	LAYERS	CABINET SIZE (INCH) OUTSIDE
KMS 22-304(G)	10×20×(48-59.8)	4	12
KMS 22-305(G)	10×20×(61.8-73.6)	5	12
KMS 22-306(G)	10×20×(75.6-87.4)	6	12
KMS 22-404(G)	14×20×(48-59.8)	4	16
KMS 22-405(G)	14×20×(61.8-73.6)	5	16
KMS 22-406(G)	14×20×(75.6-87.4)	6	16

*(G): equipped with glass baskets

Section 5 Baskets and Magic Corners



Swing Pantry

Cabinet size: 16"

KMS 22-454G - 4 layers

14"×20"×(48"-59.8")

KMS 22-455G - 5 layers

14"×20"×(61.8"-73.6")

KMS 22-456G - 6 layers

14"×20"×(75.6"-87.4")

Section 5 Baskets and Magic Corners

SECTION 5.3 LAZY SUSAN



Section 5 Baskets and Magic Corners

Pie Cut Lazy Susan - 270 Degree Revolving Wood Bottom Baskets and Wire Baskets



- ❖ Two-layer wire baskets
- ❖ Height: 22" - 32"

KMS 23-27024 (24") for 28" cabinet

KMS 23-27028 (28") for 32" cabinet

KMS 23-27032 (32") for 36" cabinet



- ❖ Two-layer **WOOD bottom** baskets
- ❖ Height: 22" - 32"
- ❖ Loading capacity: 30 lbs (14 kg) for each basket

KMS 23-27028W (28") for 32" cabinet



Section 5 Baskets and Magic Corners

Full Moon Lazy Susan - 360 Degree Revolving Wire Basket



- ❖ Two-layer wire baskets
- ❖ Height: 22" - 32"
- ❖ **KMS 23-36018** (18") for 22" cabinet
- KMS 23-36028** (28") for 32" cabinet
- KMS 23-36032** (32") for 36" cabinet

Half Moon Lazy Susan - 180 Degree Revolving Wire Basket

KMS 23-18030

- ❖ 30"(diameter) x 22-5/8"(height) for 32" cabinet
- ❖ Two-layer wire baskets



Section 5 Baskets and Magic Corners

SECTION 5.4 SOFT CLOSING MAGIC CORNERS



KMS 24-ML (left)

KMS 24-MR (right)

- ❖ Minimum door opening width **17"**
- ❖ Door mounting
- ❖ Heavy duty
- ❖ Soft closing
- ❖ Wood bottom baskets with anti-slippery surface
- ❖ D498xW860xH516 mm
- ❖ For cabinet width in size of 900-1000 mm **(36"-40")**
- ❖ Loading capacity 110 lbs (50 kg)



Section 5 Baskets and Magic Corners

KMS 24-M(R-L)W

- ❖ Minimum door opening 17"
- ❖ Heavy duty
- ❖ Soft closing
- ❖ Wood bottom baskets with anti-slippery surface
- ❖ Universal direction
- ❖ D470xW675xH515 mm
- ❖ For cabinet width in size of 800-900 mm (32"-36")



Section 5 Baskets and Magic Corners

Super Lazy Susan



KMS 24-M270

D780 x W680 x H(630-800) mm

Fit for 36" cabinet

Minimum door width: 12 $\frac{1}{2}$ "



KMS 14-M360

D780 x W680 x H(630-800) mm

Fit for 36" cabinet

Minimum door width: 12 $\frac{1}{2}$ "

SECTION 5.5 SWING TRAYS



- ❖ Soft closing
- ❖ Two-layer wood bottom trays

KMS 25-STL / 25-STR

- ❖ WDH 825x370x(600-770) mm, fit for 950 mm (38") cabinet
- ❖ Minimum door opening 17"

KMS 25-STL(s) / 25-STR(s)

- ❖ WDH 725x370x(600-770) mm, fit for 950 mm (36") cabinet
- ❖ Minimum door opening 15 $\frac{1}{2}$ "



Section 5 Baskets and Magic Corners

SECTION 5.6 SINGLE PULL-OUT WIRE BASKETS

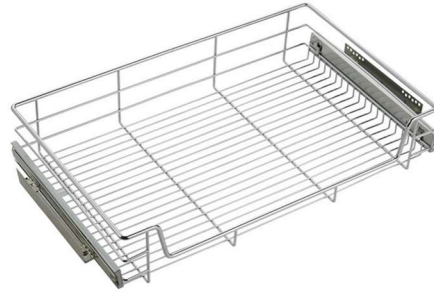

Items No.	Width (mm/inch)	Depth Height	Cabinet size (mm, inch)	note
KMS 16-400S	364(14.5")	Depth: 425mm (17") Height: 200mm (8")	400(16")	<ul style="list-style-type: none"> • Soft closing except for 16-450 and 16-500 • 16-600S, 700S, 750S, 800S and 900S with water drop plate included
KMS 16-450	414(16.5")		450(18")	
KMS 16-500	464(18.5")		500(20")	
KMS 16-600S	564(22")		600(24")	
KMS 16-700S	664(26")		700(28")	
KMS 16-750S	714(28")		750(30")	
KMS 16-800S	764(30")		800(32")	
KMS 16-900S	864(34")		900(36")	

Section 5 Baskets and Magic Corners

SECTION 5.7 STRESS TYPE ELEVATOR BASKET



	Cabinet Inside Width	FEATURES:
KMS 16-Elev 600	564-568mm (22-9/32")	<ul style="list-style-type: none"> • Soft closing • easy installation • for upper cabinet with 11-1/2" depth • Minimum cabinet height 22" • Capacity 12 kg
KMS 16-Elev 800	764-768mm(30-5/32")	
KMS 16-Elev 900	864-868mm (34-3/32")	

SECTION 6 WOOD CARVING

SECTION 7 MISC. HARDWARE

SECTION 7.1 SHELF SUPPORT

SHELF SUPPORT 1

Material: Zinc alloy
 Finish: Nickel
 Size: 7 or 5 mm
 other: with ring or no ring



SHELF SUPPORT 2

Material: Zinc alloy
 Finish: Nickel
 Size: 5x16 mm
 other: with plastic cover or no



SHELF SUPPORT 3

Material: plastic & iron
 Finish: zinc & transparent
 Size: 5 mm



SHELF SUPPORT 4

Material: Zinc alloy
 Finish: Nickel
 Size: 5 mm



SHELF SUPPORT 5

Material: Zinc alloy
 Finish: Nickel
 Size: 6 mm



SHELF SUPPORT 6

Material: Zinc alloy
 Finish: Nickel
 Size: 5 mm



SHELF SUPPORT 7

Material: plastic
 Finish: white
 Board thickness: 16 mm



SHELF SUPPORT 8

Material: Alum.
 Finish: MATT
 Type: Rack
 Size: 3.66 m/pcs



Shelf Support Continued

SHELF SUPPORT 9

(for Glass)

Material: Zinc alloy

Finish: Transparent
and clear

Size: 5 mm with
screw



SHELF SUPPORT 10

Material: plastic and
clear

Finish: Transparent
and clear

Size: 5 mm

Board thickness: 16
mm



SHELF SUPPORT 11

(for Glass)

Material: Zinc alloy

Finish: Transparent
and clear

Size: 5 mm



SECTION 7.2 FLAY STAY / BRACKETS

FLAP STAY (LIFT UP) MECHANISM



Flap Stay 1

Material: Zinc alloy
Finish: Nickel
Spec.: 180 deg. Turning
Capacity: 18 kg



Flap Stay 2

Material: Zinc alloy
Finish: Nickel
Spec.: 360 deg. Turning
Capacity: 18 kg



Hydraulic Flap Stay

Material: Zinc alloy + iron + plastic
Finish: paint
Free stay and closing
Capacity: 16 kg/each



Gas Spring

Material: zinc alloy + plastic + iron
Finish: grey
Capacity: 100 N



Lift Up Flap Support

Material: Iron + Zinc
Finish: Nickel Plated

Section 7 Misc. Hardware

L BRACKETS



Connector 2-1

Material: iron

Finish: nickel

Size: 25X25X44 mm (T=1.2mm)



Connector 2-2

Material: iron

Finish: nickel

Size: 19x19x16 mm (T=1.5mm)

SLIDING DOOR MECHANISM



Roller for Sliding Door

Material: iron + plastic

Finish: silver + red

Capacity: 30 kg



Guid for Sliding Door

Material: Aluminum

Finish: oxidation

Size: 3m/pcs

SECTION 7.3 LEGS, CASTSORS, AND GLIDES

FURNITURE LEG

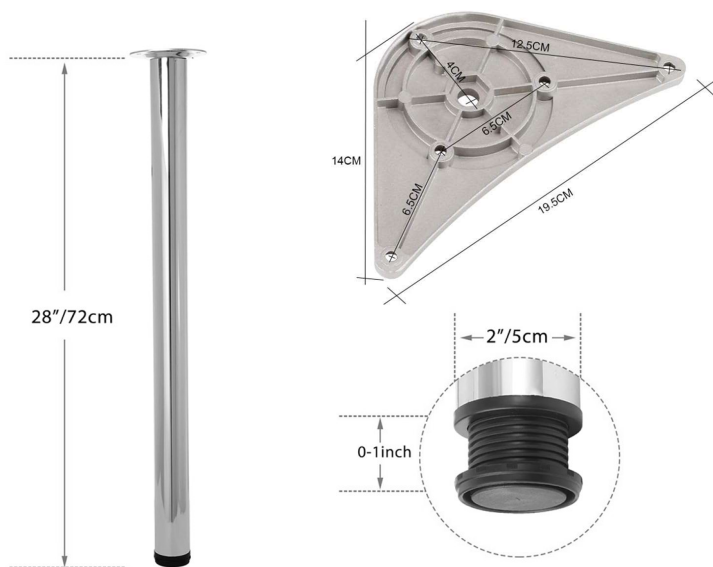

Furniture Leg

Height: 28 inches (1" adjustable by leveler)

Chrome finish and adjustable

Diameter: 2 inches

ADJUSTABLE CABINET LEGS



Color: black

Leg 1

Adjust height from 4"-6.8"

Leg 2

Adjust height from 3.5"-5.5"

FURNITURE LEGS



Furniture or Vanity Leg

Material: Stainless steel
Finish: nickel
Shape: round, square

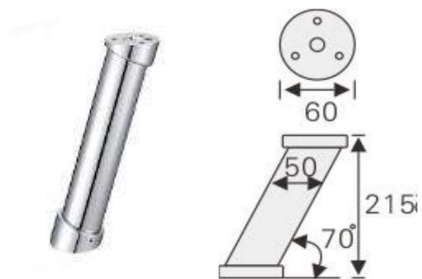

Bar Leg

Finish: chrome
Size: 2 inch (50 mm) in diameter, 8.3 inches' high

CASTORS AND GLIDES



Castor

Medium duty
Size: 3" and 5" diameter with brake, supporting part 1.25" high



Glide

Plastic cap with steel needle
Cap size: 15 mm
Needle size: 18 mm
Color: white

Section 7 Misc. Hardware

SECTION 7.4 CLOSET PARTS

ROUND CLOSET RODS: 1" CHROME



Diameter: 1 inch (25 mm)
Length: 10 feet (3 meters)
Finish: chrome



BRACKET 1



BRACKET 2



BRACKET 3 (with screw)

Brackets



ENDING BRACKET



MIDDLE BRACKET

ROUND CLOSET RODS - 1" BLACK



Diameter: 1 inch (25 mm)
Length: 10 feet (3 meters)
Finish: matte black



BRACKET (with screw)

Brackets



MIDDLE BRACKET

Section 7 Misc. Hardware

ROUND CLOSET RODS - 1-1/4" CHROME

Brackets



Diameter: 1-1/4 inch (32 mm)
Length: 10 feet (3 meters)
Finish: chrome



BRACKET 1



BRACKET 2

OVAL CLOSET RODS: CHROME

Brackets



Size: 1-1/2 x 3/4 inch (38 x 19 mm)
Length: 10 feet (3 meters)
Finish: chrome



BRACKET 1



BRACKET 3



BRACKET 2



MIDDLE BRACKET

Section 7 Misc. Hardware

OVAL CLOSET RODS: BLACK

Brackets



Size: 1-1/2 x 3/4 inch (30 x 15 mm)

Length: 10 feet (3 meters)

Finish: black



BRACKET 1



BRACKET 3



BRACKET 2



MIDDLE BRACKET

SECTION 7.5 BUMPER, BUFFER, PIANO HINGE

DOOR BUMPER (CLEAR)

Bumper 1: $\Phi 8.5$ mm (0.335") X H 2.2 mm (0.087")

Bumper 2: $\Phi 9.5$ mm (0.375") x H 3.8 mm (0.15")

Bumper 3: $\Phi 9.5$ mm (0.375") x H 3.2 mm (0.125")



DOOR BUFFER WITH PLATE



Buffer 1



Buffer 2



Buffer 3



Buffer 4



Buffer 5

PIANO HINGE

Material: stainless steel

Finish: stain

Size: L 1800mm (72")xW38 mmx1.2 mm (thickness)



SECTION 7.6 GLASS RACK

METAL GLASS RACK, FINISH: CHROME



Single Glass Rack

W108mm (4-1/4") × D267mm (10-1/2") × H70mm (2-3/4")



Double Glass Rack

W210mm (8-1/4") × D267mm (10-1/2") × H70mm (2-3/4")

WOOD GLASS RACK:



Maple wood

Size: 96"x3"x1" (LWH)

Section 7 Misc. Hardware

SECTION 7.7 PVC COVER, GROMMET, SPACER

PVC COVERS

PVC Cover 1

Light wood grain



PVC Cover 2

Pure white
Milk white

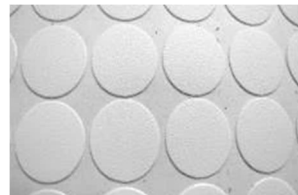

PVC Cover 3

Red wood



PVC Cover 4

Dark chocolate

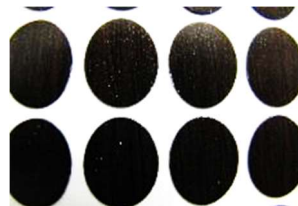

PVC Cover 5

Black

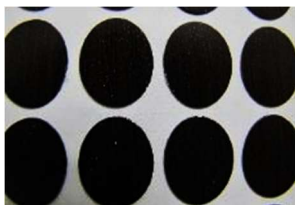

PVC Cover 7

Grey



PVC Cover 8

Maple

CABLE GROMMET

Material: plastic

Finish: black

Size: 80 mm



SPACER

Size:

L=1-7/8"

W=7/8"

H=1"



SECTION 7.8 CUTLERY, DISH AND PLATE RACK

CUTLERY

Cutlery 1	330x483x50mm (13"x19"x2")
Cutlery 2	390x480x60mm (15"x19"x2.5")
Cutlery 2A	430x480x60mm (17"x19"x2.5")
Cutlery 2B	530x480x60mm (21"x19"x2.5")
Cutlery 3	630x480x60mm (25"x19"x2.5")
Cutlery 4	730x483x50mm (29"x19"x2")
Cutlery 5	830x483x50mm (33"x19"x2")



DISH AND PLATE RACKS



Dish Rack 1

Size: H16-3/4"xW22"xD7-1/4"
with water drop plate



Dish Rack 2

Size: H6"xW(8.5-16)"x6"



Plate Rack

Size: L12-1/8"xW8"xH4"

Section 7 Misc. Hardware

SECTION 7.9 WRAP

Wrap 1 3"×1000'

Wrap 2 5"×1000'

Wrap 3 12"×1000'

With handle



SECTION 7.10 SOAP TRAY

Size: W14"×D2-1/2"×H4"

Color: white

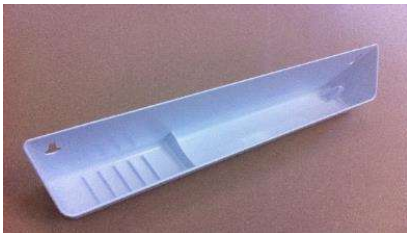

Soft closing Scissor Hinge for Soap Tray



SECTION 7.11 ANTI-SLIP MAT

W=500 mm

Color: Grey

SECTION 7.12 DRAWER DIVIDER

Color: White or Dark Grey



L connector



T connector



+ connector



Divider plate: 60 mm (2-3/8") high x 2000 mm (78-3/4") long

1. Easy to cut and assemble
2. Customize your drawer divider for your home

Section 7 Misc. Hardware

SECTION 7.13 EDGE BANDING

ITEM	DESCRIPTION
	<p>WHITE 7/8 X 0.018 X 1200</p>
	<p>WHITE 7/8 X 1MM X 500</p>
	<p>WHITE HI GLOSS 7/8 X 0.018 X 600</p>
	<p>WHITE HI GLOSS 7/8 X 1MM X 500</p>
	<p>SUPER WHITE HI GLOSS 7/8 X 0.018 X 600</p>
	<p>SUPER WHITE HI GLOSS 7/8 X 1MM X 500</p>
	<p>BLACK 7/8 X 0.018 X 1200</p>
	<p>BLACK 7/8 X 1MM X 500</p>

SECTION 8 GARBAGE BINS

SIZE - 10-5/8" (FOR 12" CABINET)



KMS WB 11-2

- ❖ W 265mm (10-5/8") x H 400mm (16") x D 480mm (19-1/4")
- ❖ 1×20L bin+1×10L bins
- ❖ with door mount bracket and soft-closing Sidemount slide
- ❖ For under sink & by the pipe

UNDERMOUNT INSTALLATION

SIZE - 13-5/8" (FOR 16" CABINET)



KMS WB 14-2

- ❖ W 340mm (13-5/8") x H 420mm (16-3/4") x D 480mm (19-1/4")
- ❖ 2×20L bin
- ❖ with door mount bracket and soft-closing Sidemount slide

UNDERMOUNT INSTALLATION

SIZE - 15-5/8" (FOR 18" CABINET)



KMS WB 16-2

- ❖ W 395mm (15-5/8") x H 420mm (16-3/4") x D 480mm (19-1/4")
- ❖ 2×20L bin
- ❖ with door mount bracket and soft-closing

UNDERMOUNT INSTALLATION

Section 8 Garbage Bins

SIZE - 18-5/8" (FOR 20" CABINET)



KMS WB 19-2

(2x34L) bins

KMS WB 19-3

(1x34+2x17L) bins

KMS WB 19-4

(4x17L) bins

- ❖ W465mm(18-5/8")×H495mm(19-3/4")×D494mm(20")
- ❖ with door mount bracket
- ❖ soft-closing or regular
- ❖ heavy duty

SIDEMOUNT INSTALLATION

SIZE - 20-5/8" (FOR 22" CABINET)



KMS WB 21-2

(2x34L) bins

KMS WB 21-3

(1x34+2x17L) bins

KMS WB 21-4

(4x17L) bins

- ❖ W529mm(20-5/8")×H540mm(21-5/8")×D494mm(20")
- ❖ with door mount bracket
- ❖ soft-closing
- ❖ heavy duty

UNDERMOUNT INSTALLATION

Section 8 Garbage Bins

UNDERSINK GARBAGE BIN



KMS WB 15x2S

- ❖ W 340mm (13-5/8") x H 320mm (12-3/4") x D 480mm (19-1/4")
- ❖ 2x15L bin
- ❖ soft-closing
- ❖ For under sink

UNDERMOUNT INSTALLATION

ROUND STAINLESS STEEL GARBAGE BIN



KMS S.S. Dust Bin

- ❖ Φ 290 mm (11.5") x H350 mm (14") x W350 mm (14")
- ❖ 14L
- ❖ Swing out with door

SECTION 9 CLOSET AND STORAGE

WARDROBE LIFT

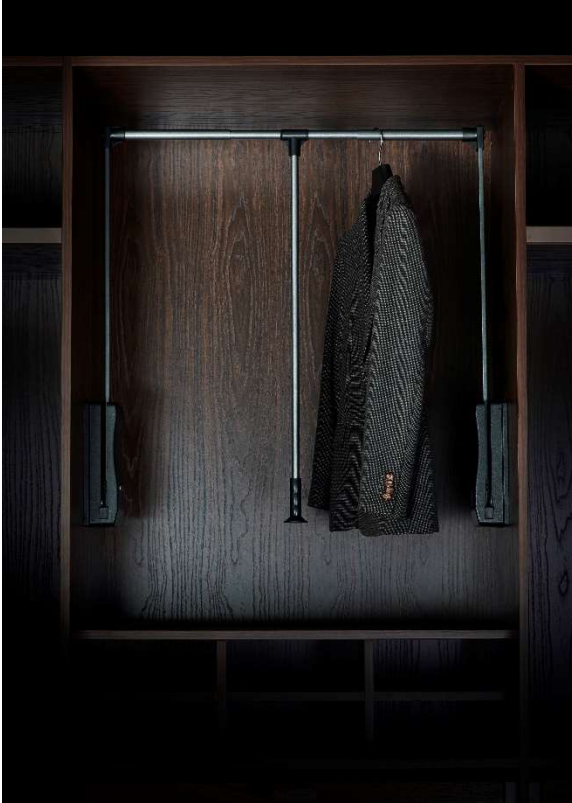

Nano dry iron tube + ABS + High-end hydraulic rod

Color: grey

KMS-102501:

W(540-690) x D140 x H820 mm

$(21\frac{1}{4} - 27\frac{1}{8}) \times 5\frac{1}{2} \times 32\frac{1}{4}$ inch

KMS-120502:

W(690-920) x D140 x H820 mm

$(27\frac{1}{8} - 36\frac{1}{4}) \times 5\frac{1}{2} \times 32\frac{1}{4}$ inch

KMS-120503:

W(920-1240) x D140 x H820 mm

$(36\frac{1}{4} - 48\frac{3}{4}) \times 5\frac{1}{2} \times 32\frac{1}{4}$ inch

CLOTHES HOLDER AND BASKET



KMS CLOTHES HOLDER 100401

Color: Grey

Size: W115 x D455 x H115 mm

$4\frac{1}{2} \times 18 \times 4\frac{1}{2}$ inch

CLOTHES HOLDER



KMS CLOTHES BASKET 120902

Layers: 4

Color: Grey

Size: W720 x D720 x H1900-2100 mm

$28\frac{1}{4} \times 28\frac{1}{4} \times (74\frac{3}{4} - 82\frac{5}{8})$ inch

KMS CLOTHES BASKET 120903

Layers: 3

Color: Grey

Size: W700 x D700 x H900-1100 mm

$27\frac{1}{2} \times 27\frac{1}{2} \times (35\frac{1}{2} - 43\frac{2}{8})$ inch

CLOTHES BASKET

PANTS RACK

KMS LEATHER PANTS RACK
100101



Color: grey

Size: W350 x D455 x H115 mm

$13\frac{3}{4} \times 18 \times 4\frac{1}{2}$ inch

KMS TOP MOUNTED DOUBLE
ROW PANTS RACK 100201

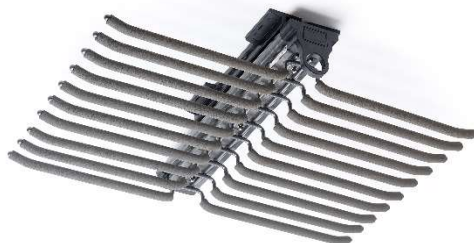

Color: grey

Size: W630 x D455 x H115 mm

$24\frac{3}{4} \times 18 \times 4\frac{1}{2}$ inch

KMS TOP LOADING V-SHAPED
PANTS RACK 100301



Color: grey

Size: W340 x D455 x H140 mm

$13\frac{3}{8} \times 18 \times 5\frac{1}{2}$ inch

TROUSER RACK



Color: grey

KMS TROUSER TRACK 150101:

W564 x D460 x H71 mm

$22\frac{1}{4} \times 18\frac{1}{8} \times 2\frac{3}{4}$ inch

KMS TROUSER TRACK 150103:

W764 x D460 x H71 mm

$30\frac{1}{8} \times 18\frac{1}{8} \times 2\frac{3}{4}$ inch

KMS TROUSER TRACK 150104:

W864 x D460 x H71 mm

$34 \times 18\frac{1}{8} \times 2\frac{3}{4}$ inch



REVOLVE MIRROR



**KMS Revolve mirror
160202**

Aluminum alloy + ABS +
three-section steel ball rail

Color: grey

Size: H1200 x W350 mm
48x14 inch



SHOE RACKS



KMS ROTATING SHOE RACK 120802:

W700 × D360 × H1070-1270 mm (6 layers)

$27\frac{1}{2} \times 14\frac{1}{8} \times (42\frac{1}{8} - 50)$ inch

KMS ROTATING SHOE RACK 120803:

W700 × D360 × H1070-1350 mm (8 layers)

$27\frac{1}{2} \times 14\frac{1}{8} \times (42\frac{1}{8} - 53\frac{1}{8})$ inch

KMS ROTATING SHOE RACK 120804:

W700 × D360 × 1070-1630 mm (10 layers)

$27\frac{1}{2} \times 14\frac{1}{8} \times (42\frac{1}{8} - 64\frac{1}{8})$ inch

KMS ROTATING SHOE RACK 120805:

W700 × D360 × H1070-1910 mm (12 layers)

$27\frac{1}{2} \times 14\frac{1}{8} \times (42\frac{1}{8} - 75\frac{1}{8})$ inch



Color: grey



Color: grey

KMS SHOE RACK 150601:

W564 × D460 × H170 mm

$(22\frac{1}{4} \times 18\frac{1}{8} \times 6\frac{5}{8})$ inch

KMS SHOE RACK 150602:

W764 × D460 × H170 mm

$(30\frac{1}{8} \times 18\frac{1}{8} \times 6\frac{5}{8})$ inch

KMS SHOE RACK 150604

W864 × D460 × H170 mm

$(34 \times 18\frac{1}{8} \times 6\frac{5}{8})$ inch

Section 9 Closet and Storage

SORTING BOXES

Color: grey

KMS Flannelette sorting box 150701G:

W564xD460xH71 mm ($22\frac{1}{4} \times 18\frac{1}{8} \times 2\frac{3}{4}$) inch

KMS Flannelette sorting box 150703G:

W764xD460xH71 mm ($30\frac{1}{8} \times 18\frac{1}{8} \times 2\frac{3}{4}$) inch

KMS Flannelette sorting box 150704G:

W864xD460xH71 mm ($34 \times 18\frac{1}{8} \times 2\frac{3}{4}$) inch



Color: grey + orange

Leather sorting box 150701R:

W564xD460xH71 mm ($22\frac{1}{4} \times 18\frac{1}{8} \times 2\frac{3}{4}$) inch

Leather sorting box 170703R:

W764xD460xH71 mm ($30\frac{1}{8} \times 18\frac{1}{8} \times 2\frac{3}{4}$) inch

Leather sorting box 150704R:

W864xD460xH71 mm ($34 \times 18\frac{1}{8} \times 2\frac{3}{4}$) inch

STORAGE BASKET

Color: grey

Glass storage basket 151701:

W564xD460xH165 mm ($22\frac{1}{4} \times 18\frac{1}{8} \times 6\frac{1}{2}$) inch

Glass storage basket 151703:

W764xD460xH165 mm ($30\frac{1}{8} \times 18\frac{1}{8} \times 6\frac{1}{2}$) inch

Glass storage basket 151704:

W864xD460xH165 mm ($34 \times 18\frac{1}{8} \times 6\frac{1}{2}$) inch



FOLDING IRONING BOARD

Specifications:

- Material: Steel, ABS, Cotton, Wood
- Style: Modern Simplicity
- Color: Gray
- Bearing Capacity: 45kg
- Recommended Size Of Wardrobe: Width 340 x Depth 480 x Height 170mm
- Product Size: Approx. 81x31x15cm (31.89" L x 12.21" W x 5.91" H)

